

Tetria Ceiling Tiles™

Installation Manual



For more information, please visit 3-form.com or call 800.726.0126

JUNE 2018 | TETRIA | REV 002 © 2018 3form, Inc. All rights reserved.

Overview

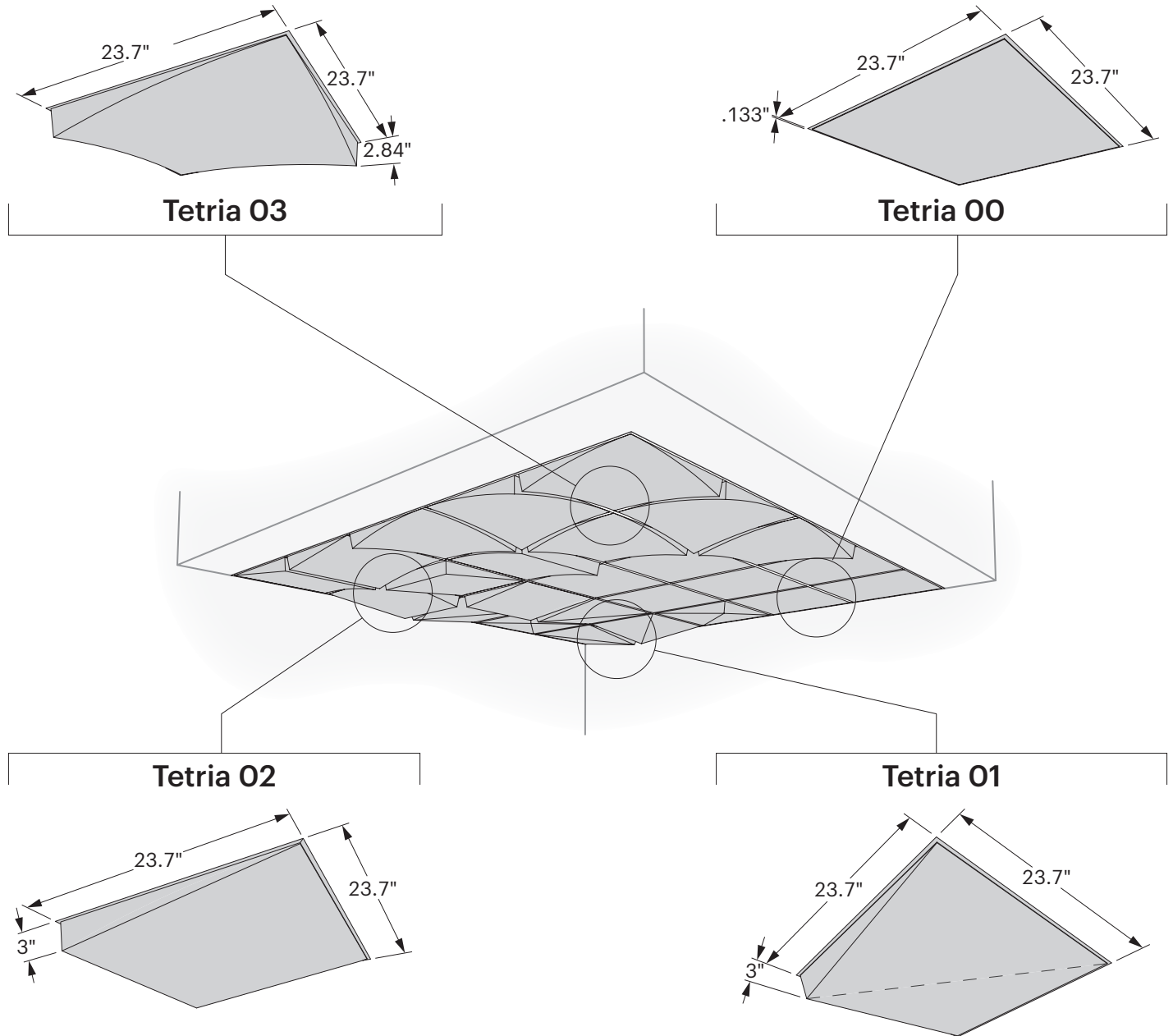

Installation

1 Preparation

Prepare your ceiling to make sure your grid is set with 2'x2' openings.

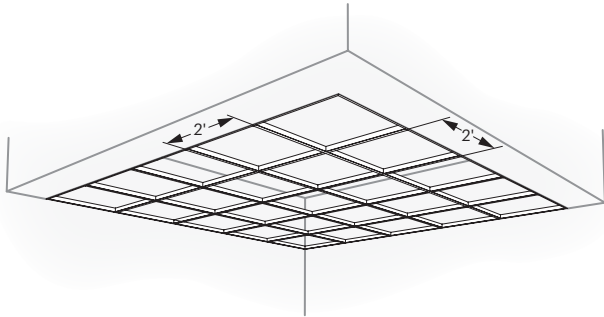

d If there is an obstruction in the ceiling (can light, non-square tile, sprinkler, etc.), a square 24"×24" Tetria OO Tile will be supplied with your order. Use the configuration tool to indicate this upon specification.

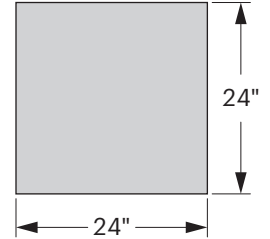

e To trim Tetria Tiles, measure opening dimension from "on center" or spline dimension.

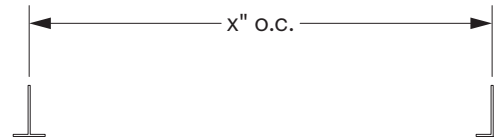

2 Install Tile

Angle the tile up in the T-grid cavity and drop the Tetria Tile so that all edges are resting flush in the grid system.

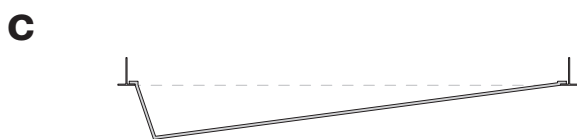
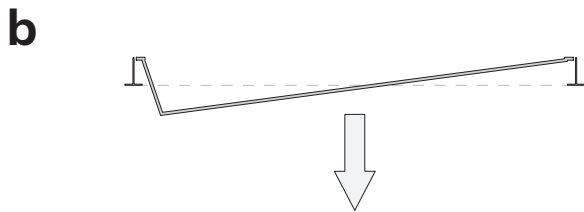
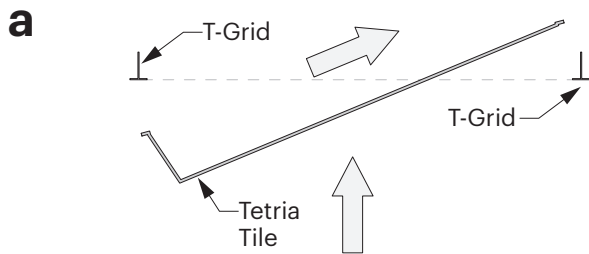

f Using a straight edge and utility knife, score and cut the material with the Merino side up.

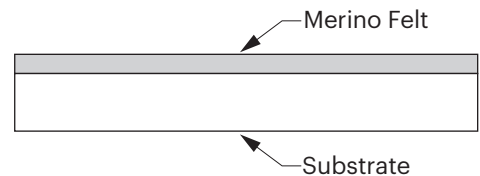

g For light fixtures and non-straight cutouts, take special care to cut/trim the Tetria OO Tile to fit the object.

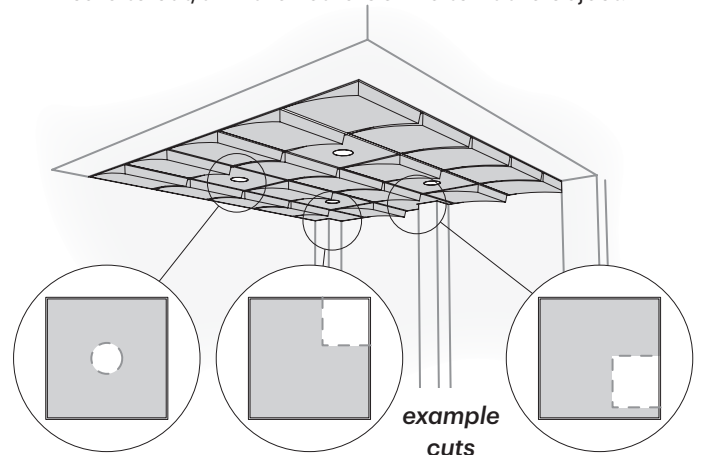

Product Description

Tetria allows you to select from 3 different dimensional tiles to use in your existing T-grid drop ceiling application. Bring color, high acoustic performance and dimensional interest to your space.

Design Options

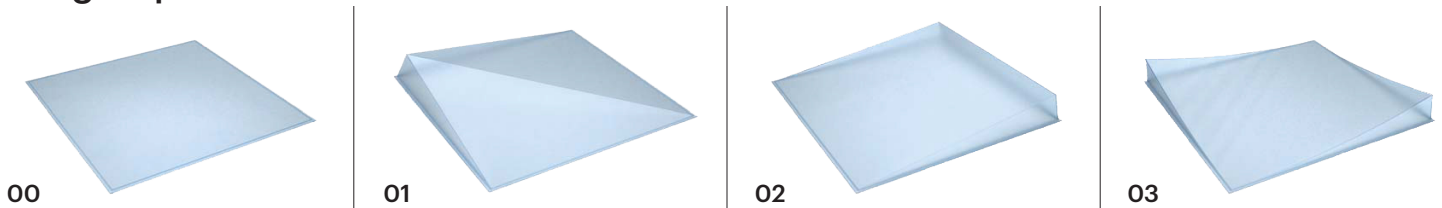

Grid Compatibility

Tetria is designed to work with 15/16" T-grid in a 2'x2' format. T-grid can be obtained via your local ceiling contractor.

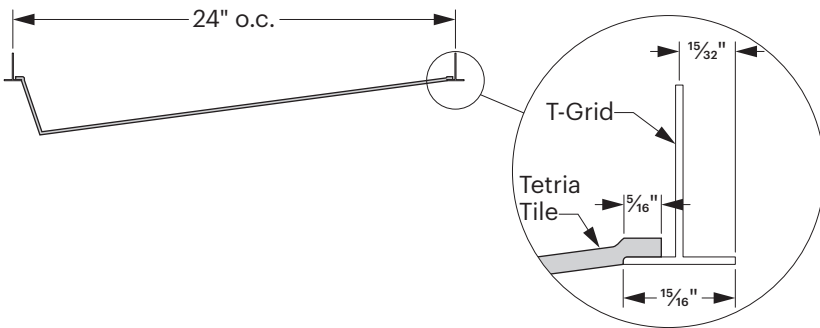

Finish

Tetria can be specified in any of 3form's 30 Merino Felt options.



Sound Absorption Test Results

SOLUTION	TEST - ASTM C423-09	RESULT
Tetria Tile	NRC (Noise Reduction Coefficient)	0.85
	SAA (Sound Absorption Average)	0.83
	Alpha-w	0.85

Flammability/Smoke Test Results

Tetria Tiles have been independently tested and meet the criteria for approved interior finishes as described in the 2018 International Building Code®.

TEST	TETRIA TILE	RESULT
ASTM E84		
Flame Spread	25	Class A: 0-25
Smoke generated	100	<450

Panel Weight

MATERIAL	WEIGHT FLUX
Tetria Tile	0.38 lb/ft ² (1.89 kg/m ²)