

Ready To Go

SimpleSpec 400.11™

Installation Manual

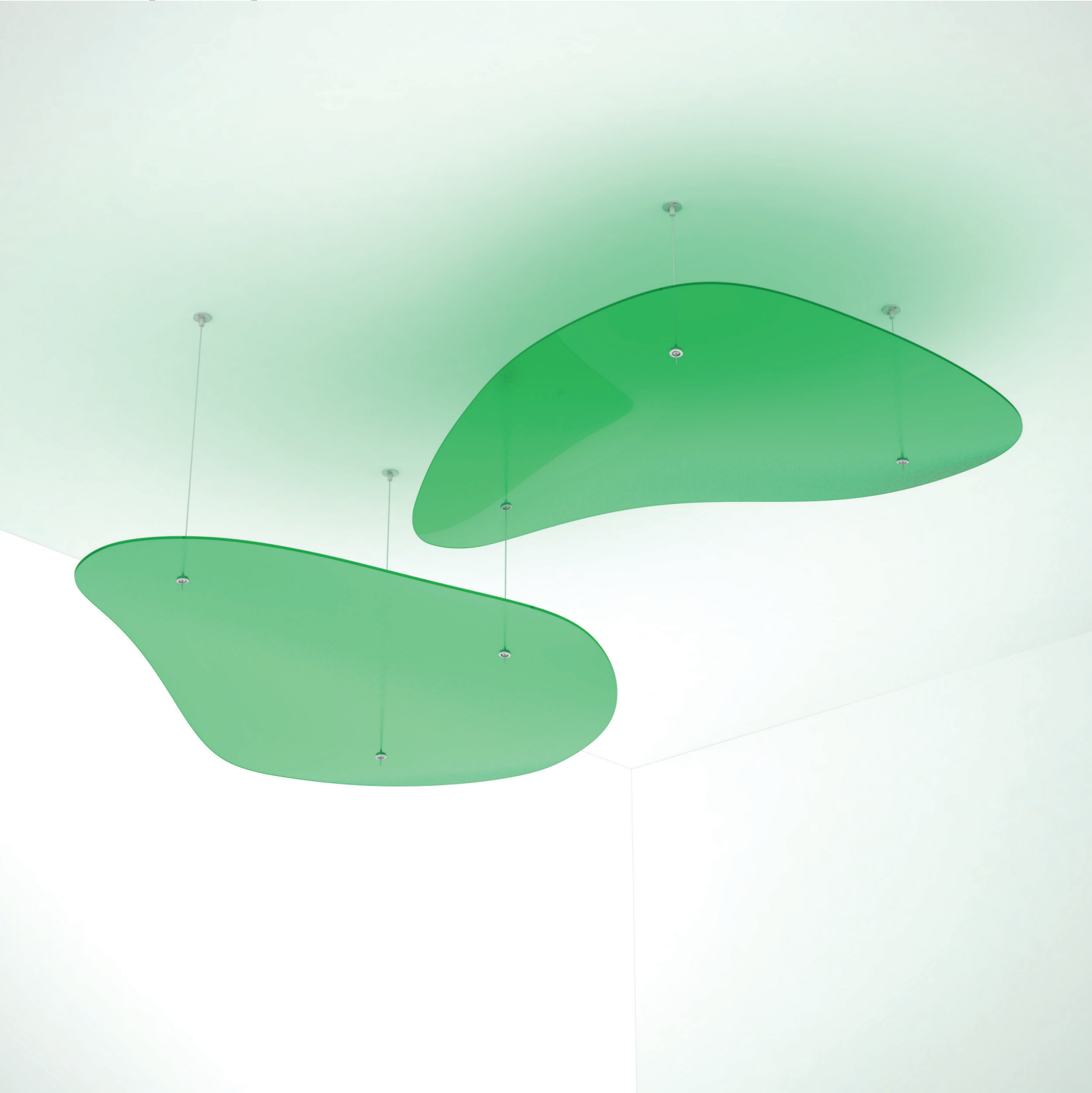



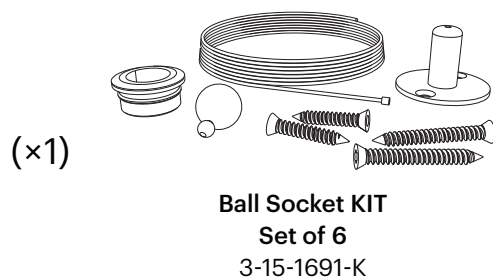
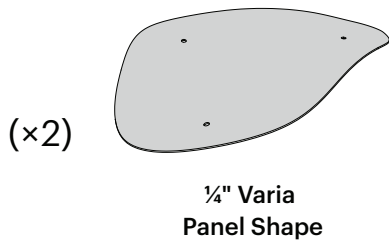

For more information, please visit 3-form.com or call 800.726.0126

JUNE 2017 | MAN-RTG-400-11 | REV 001 © 2017 3form, Inc. All rights reserved.

Contents Overview

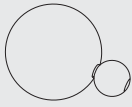
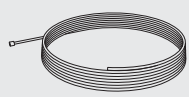
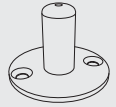

=

	+		+		+
(x6) Bottom Release Gripper 3-15-1976		(x6) 1/16" Cable 3-15-1674		(x6) Cable Coupler 3-15-1675	
	+		+		
(x6) Socket Cup 3-15-1689		(x12) 3/16" x 1-1/4" Fastener for Wood 3-15-0841		(x12) 3/16" x 1-1/4" Fastener Multi-substrate 3-15-0842	

Overview

400.11 offers an accenting ceiling feature using suspended heat formed Varia. The ball and socket cable hardware is minimalist and easy to use.

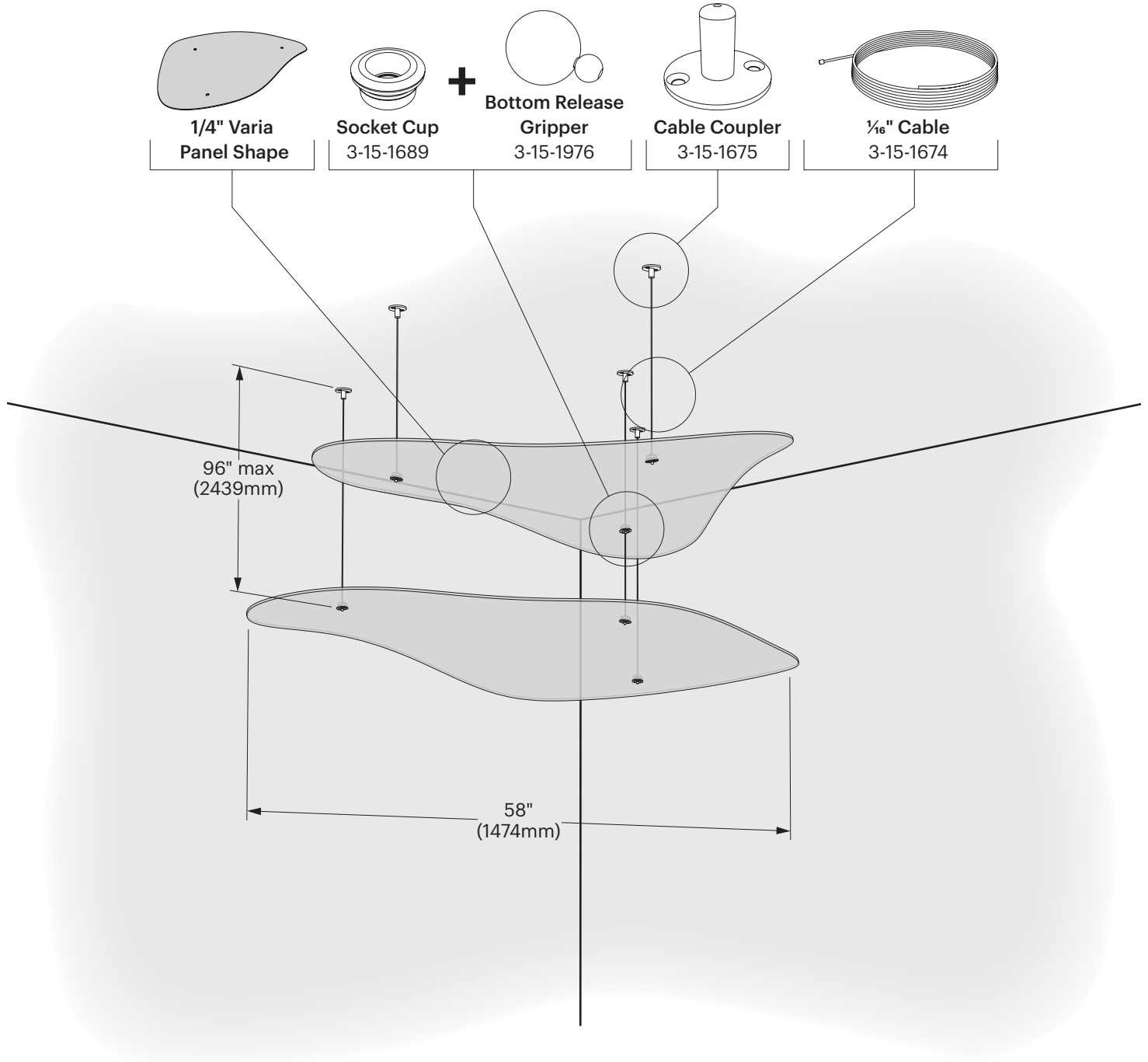

Installation Required Tools

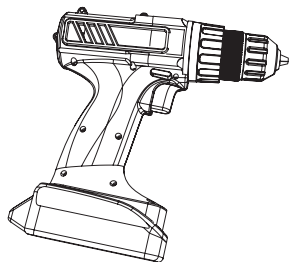

Drill

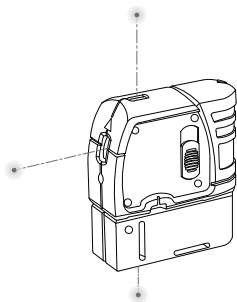

Laser Level

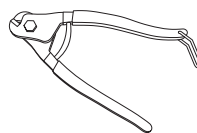

Cable Cutters

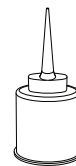

Super Glue

1 Position and Mark Mounting Locations

Place panel on floor in desired position. Use laser level to mark mounting surface aligned with holes. Take into account the desired angle of panel and adjust holes accordingly. You can also splay cables out to prevent swaying from HVAC in longer installations.

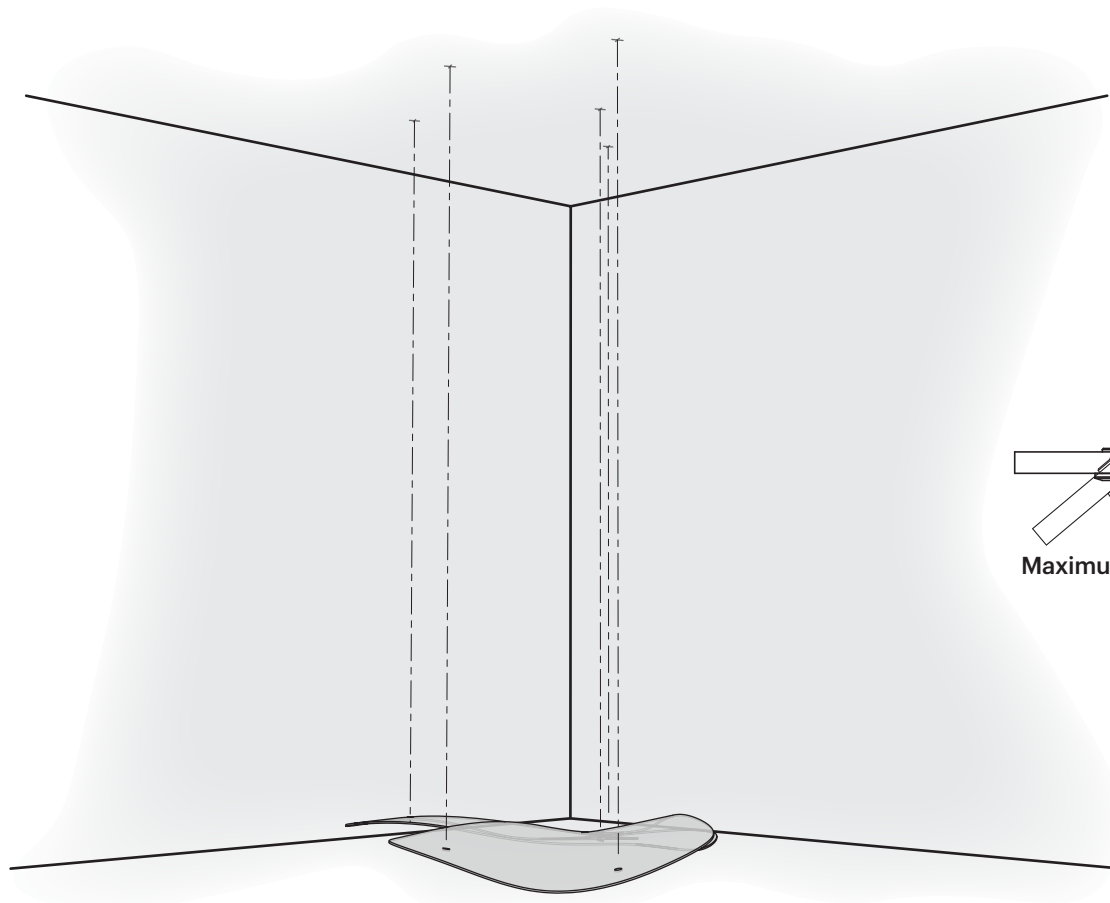

Installation

2 Install Cables and Couplers into Mounting Surface

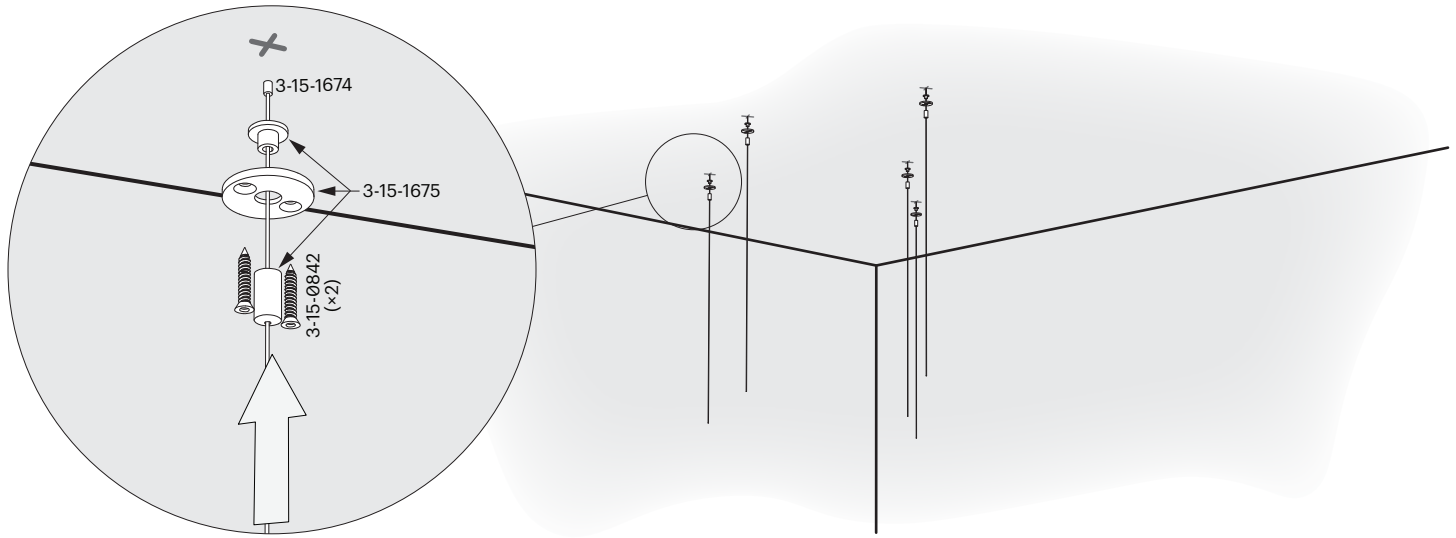

3 Install Sockets and Grippers

Install sockets into panel and feed cable through sockets and into grippers. Pull through to suspend panel.

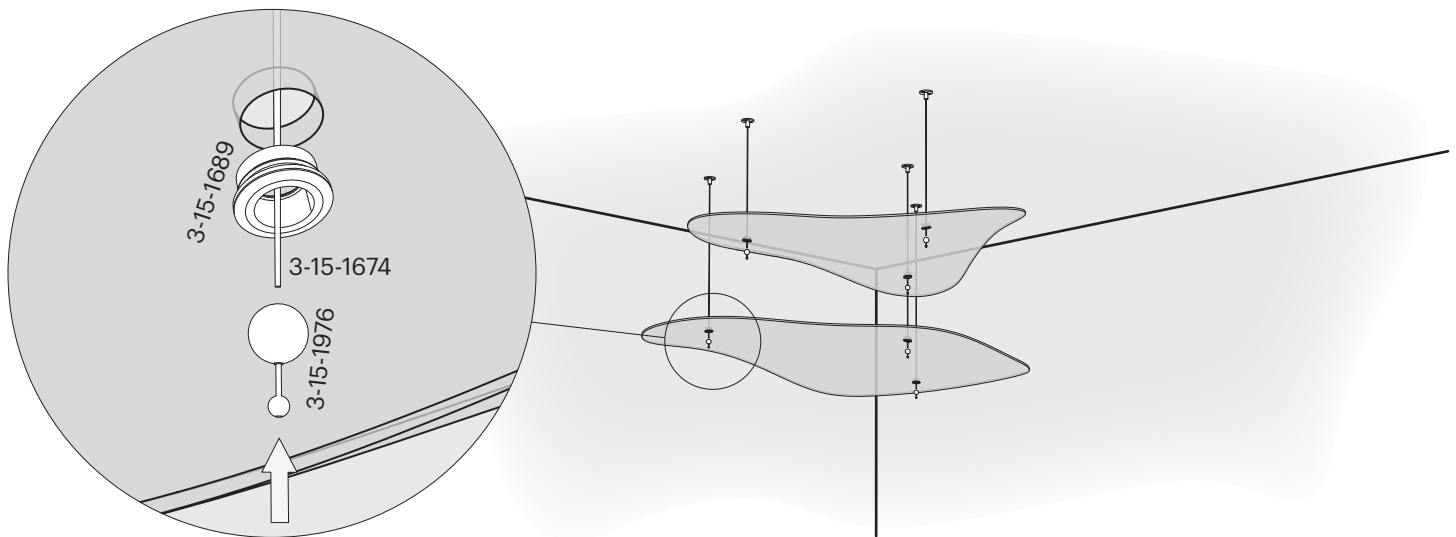

Installation

4 Trim Cables and Glue Ends

